

# Data Sheet



Article number: 7806141110240200

Description: BEGE flangeencoder for 63B5  
MN140-11-1024-2 (20m) 5-24V

## Measures

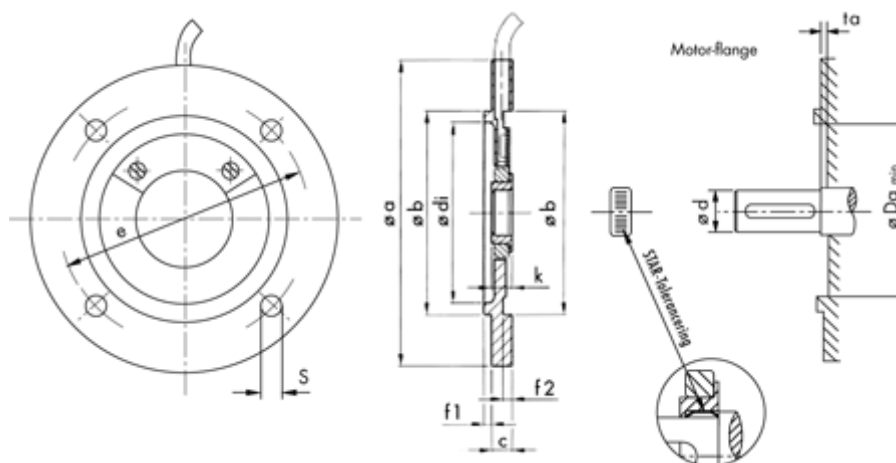

$a = 140$	$f2 = 4.0$
$b = 95$	$k = 7$
$c = 7$	$s = 9$
$d = 11$	$ta = 2$
$Da = 60$	
$di = 85$	
$e = 115$	
$f1 = 3.5$	